

# Your Yard SOLUTIONS LTD.

## Fence Installation Guide

---

### Step 1- Pounding Posts

- Before you begin pounding it is important to have the utilities checked to avoid puncturing any unseen lines.
- It is also important to check property lines to avoid encroaching on neighbors' property.
- Steel posts should be spaced 96" (8') on center (or 94" inside to inside) and pounded at least 3.5' to 4' deep. (for 6' sections posts should be 73.5" on center).
- use a level to ensure that the steel posts are as plumb as possible while pounding
- In order to get each fence line straight it is best to run a string line at least three inches within your property to avoid encroaching.

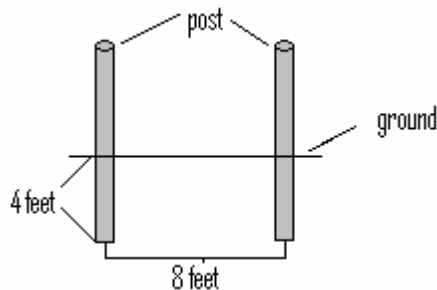

### Methods for pounding Posts

- A hand post pounder or pneumatic post pounder can be used.

### Step 2- Setting post adapters

- Each post gets two adapters one top and one bottom.
- Next dig around bottom of posts and slip the adapters on (diagram A)
- Next, using a level set the adapters of all the end and corner posts use self tapping screws to keep them in place, making sure they are plumb in both directions.

## Diagram A

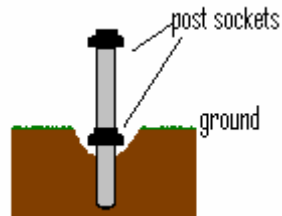

## String Line

- Set the string line on the top adapters for each run of fence from end posts to corner posts.
- Adjust remaining adapters to string and fasten to posts.
- Then using the level, plumb the remaining bottom adapters with the top adapters and fasten to the posts.

### Top view:

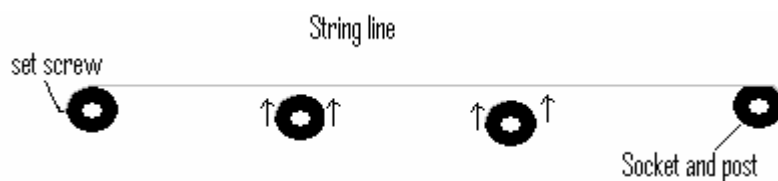

## Step 3- Setting posts for height

- Place all 5x5 vinyl posts over the steel posts & adapters (long end down) making sure they are in the correct positions, ie: line, corner, and end.
- Insert bottom rails into post. **Note: bottom rails are the rails with the aluminum insert.**
- First set end posts and corner posts for height by inserting a screw (or two) into the lower adapter through the vinyl post. Then by running a string over top and between the end and corner posts you can set the rest of the posts to height by lifting to string and fastening to bottom adapter...

## Diagram for step 3

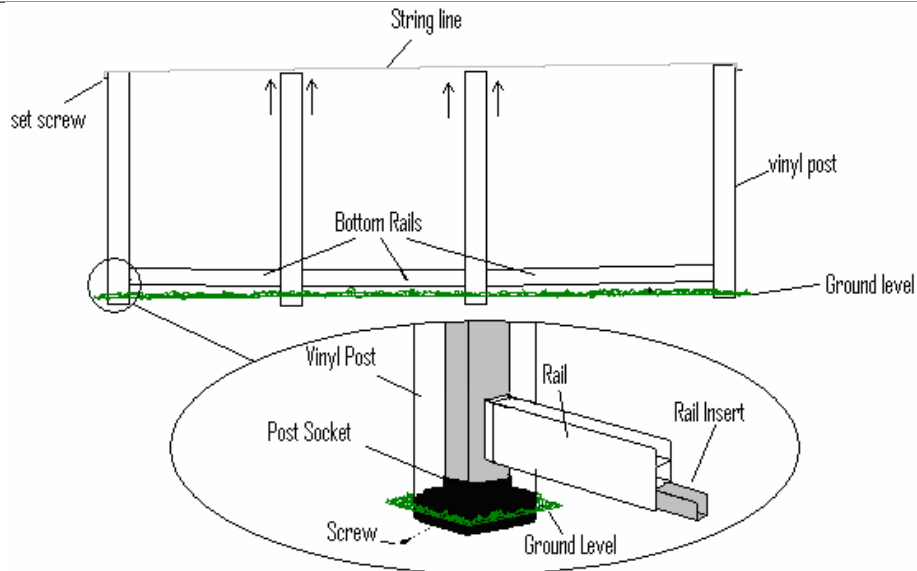

## **Step 4- Fastening 'U channel'**

- The 'U Channel' is screwed to the post between the rail holes

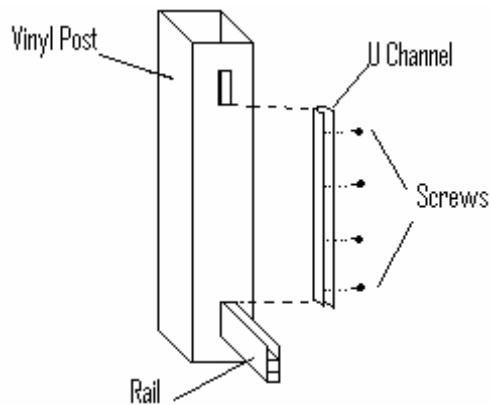

- In order to add stability make sure one of the screws hits the upper black adapter inside every post on both sides...

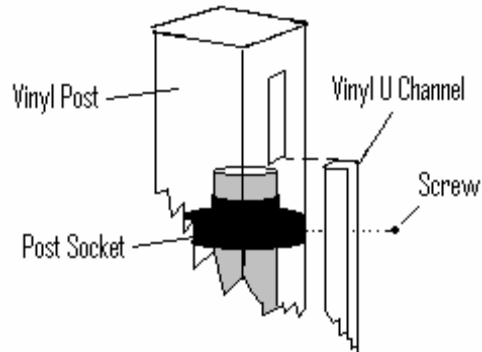

## **Step 5- Panels and Top Rails**

- Insert interlocking fence panels into bottom rails.

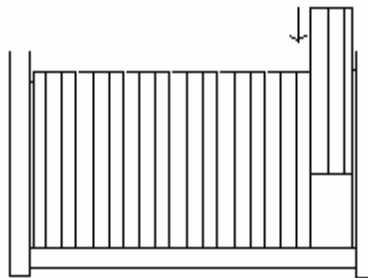

- In some sections a panel may need to be ripped (or a shim hidden behind 'u channel) so the boards are snug.
- Next insert top rails.
- If fence is picket or lattice accent it is easiest to put the accent together on ground first and insert after.

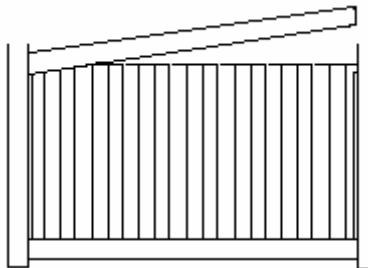

- Glue on Caps.

## **Step 6 - Sit on your lawn Chair and enjoy your Maintenance Free Vinyl Fence!!**

For any further questions contact our office at 306- 382-1759.